

# IB series

Snap-in sealed pushbutton switches •  
bushing Ø 12 mm • momentary



## DISTINCTIVE FEATURES

Snap-in models  
Compact, lightweight  
Tactile feedback  
Sealed to IP54



## ENVIRONMENTAL SPECIFICATIONS

- Front panel sealing according to IEC 60529 : IP54
- Shock resistance : 100 g according to IEC 512-4, test 6c
- Vibration resistance : 10-500 Hz - 10 g according to IEC 512-4, test 6d
- Salt spray : IEC 512-6, test 11f
- Operating temperature : -40 °C to +85 °C (-40 °F to +185 °F)



## ELECTRICAL SPECIFICATIONS

- Max. current/voltage rating with resistive load :  
400 mA 32 VAC - 100 mA 48 VDC
- Initial contact resistance : 50 mΩ max.
- Insulation resistance : 1 GΩ min. at 500 VDC
- Dielectric strength : 1,000 Vrms
- Electrical life at full load : 500,000 cycles



## GENERAL SPECIFICATIONS

- Panel thickness : 0.8 mm (.031) min. - 1.8 mm (.071) max.
- Total travel : 1.7 mm (.066) ± 0.3 mm
- Typical operating force : 4 N ± 3 N
- Low level or mechanical life : 1,000,000 cycles
- Soldering : 300 °C (572 °F) max. for 3 seconds

The company reserves the right to change specifications without notice.



# IB series

Snap-in sealed pushbutton switches •  
bushing Ø 12 mm • momentary



## MATERIALS

- Case : thermoplastic UL94-V0
- Actuator : polyamide 6/6
- Bushing/bezel : polyamide 6/6
- Contacts : silver, gold plated
- Terminal seal : epoxy

APEM products may be recycled at end-of-life for the re-claiming of valuable metal components.

## AGENCY APPROVAL



2 A 125 VAC/250 VAC  
File E83438

**Availability** : consult factory for details of approved models.

**Marking** : to order switches marked UL, complete appropriate box of ordering format.



## TERMINALS

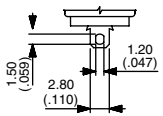

Solder lug S

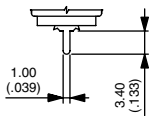

Straight P

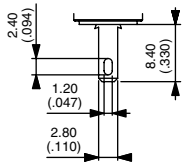

Quick-connect Z



## ELECTRICAL FUNCTIONS

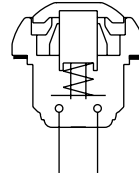

Function 3 (NO)



## MOUNTING STANDARD BEZEL

### PANEL CUT-OUT

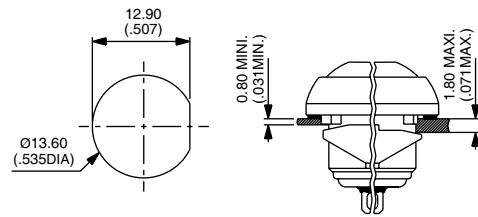

### MATRIX MOUNTING

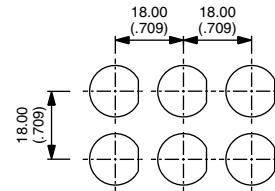

## MOUNTING REDUCED MODEL

### PANEL CUT-OUT

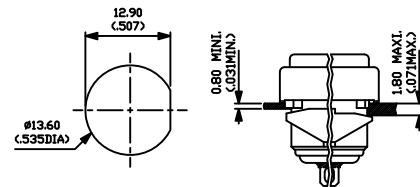

### MATRIX MOUNTING

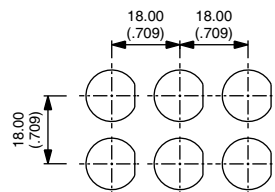

# IB series

Snap-in sealed pushbutton switches •  
bushing Ø 12 mm • momentary



## BUILD YOUR PART NUMBER

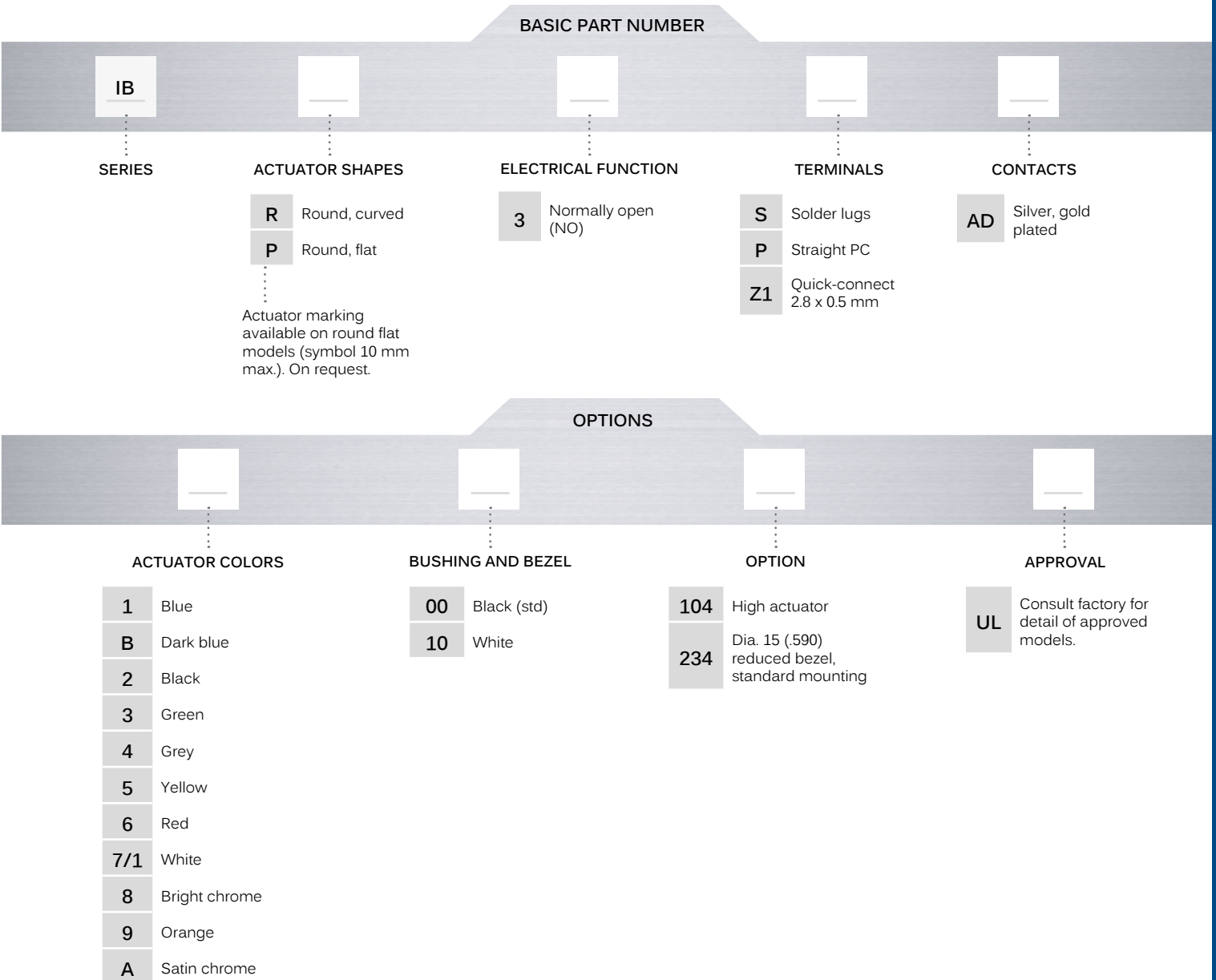

## ABOUT THIS SERIES

On the following pages, you will find successively basic part numbers of switches and options in the same order as in above chart.

- Notice** : please note that not all combinations of above numbers are available. Refer to the following pages for further information.
- A sealing boot** is available to protect the switches against frost and sand (P/N U5125). See "Sealing Boots" section of website.
- Mounting accessories** : Standard hardware supplied : 1 flat seal. Plastic nut 17 mm (.669) across flats, thickness 4 mm (.157) available on request. Part number U4248.

# IB series

Snap-in sealed pushbutton switches •  
bushing Ø 12 mm • momentary

## SOLDER LUG TERMINALS



Curved actuator  
**IBR3SAD**  Normally Open

Flat actuator  
**IBP3SAD**  Normally Open

→ FLAT

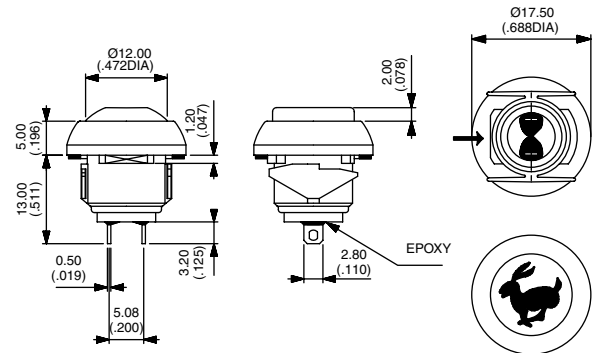

Also available with straight PC : **IB•3PAD** or quick-connect terminals : **IB•3Z1AD**

### ACTUATOR COLORS

BASIC P/N



- 1 Blue
- B Dark blue
- 2 Black
- 3 Green
- 4 Grey
- 5 Yellow
- 6 Red
- 7/1 White
- 8 Bright chrome
- 9 Orange
- A Satin chrome

### BUSHING AND BEZEL

BASIC P/N



- 00 Black (standard)
- 10 White

# IB series

Snap-in sealed pushbutton switches •  
bushing  $\varnothing$  12 mm • momentary

## OPTIONS



- 104 High actuator
- 234 Dia. 15 (.590) reduced bezel, standard mounting

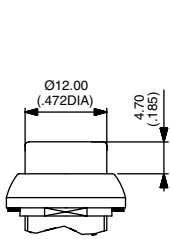

104 IBR

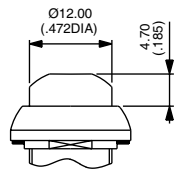

104 IBP

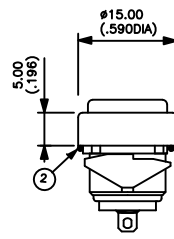

234

## AGENCY APPROVAL



- UL**  
**Availability** : consult factory for details of approved models.  
**Marking** : to order switches marked UL, complete appropriate box of ordering format.

## X-ON Electronics

Largest Supplier of Electrical and Electronic Components

*Click to view similar products for [Pushbutton Switches](#) category:*

*Click to view products by [Apem](#) manufacturer:*

Other Similar products are found below :

[LW1L-M1C10V-A](#) [LW2L-A1C20M-GD](#) [LW2L-M1C20M-A](#) [60324L](#) [M7E-HRN2](#) [67021K512](#) [67081K512X](#) [701PB580](#) [719-5504-000](#)  
[MDPSSGLFS](#) [810KSV30B](#) [FLT 2U EE 01A](#) [MML21KA3ABK](#) [MML23KA3AC05K-001](#) [MML23KW3AA01W](#) [8418K2](#) [8646AB6X718UL](#)  
[8646ABUL](#) [FSDWH](#) [9001KXRK](#) [9001T8BK](#) [9533CD4+U574+U4922](#) [1203MRA](#) [A22EM01S](#) [A595](#) [1202A6](#) [12037A2ULCSA](#) [1203A2UL](#)  
[ABD122N-B](#) [1211390004](#) [ABN111-Y](#) [ABN400-R](#) [1211500044](#) [1211580012](#) [1212MRA](#) [1232A6NF](#) [RA3CSH6A](#) [1241.1183.7047](#)  
[1241.2511](#) [1241.3428](#) [1223A2ULCSA](#) [1223MRA](#) [1232AX2119](#) [1241.1183.8000](#) [1241.1183.8029](#) [1241.2506](#) [1241.2606](#) [12MA6](#)  
[1301940184](#) [RELBARF6X10\(PLASTIC\)](#)